

SCHEMA TECNICA

Famiglia: **SOCRATE OUTDOOR**

Design: **Mario Trimarchi, Caimi Lab**

Socrate Outdoor è un sistema d'arredo per esterni e interni, modulare e componibile, pensato come un elemento polivalente dotato di accessori che lo rendono funzionale per svariati utilizzi outdoor, per piccoli e grandi spazi. I differenti colori di strutture, ripiani e accessori possono essere combinati fra loro per un inedito effetto cromatico.



Codici: **4600E-AN, 4600E-TU, 4800E-AN, 4800E-TU**

Dimensioni: 45 x h. 160 cm (4600E-XX)
45 x h. 83 cm (4800E-XX)

Descrizione: montanti in tondino d'acciaio elettrosaldato, zincato e verniciato con polveri epossidiche per esterni, colore grigio antracite o turchese pastello, composti da tre tondini \varnothing 7 mm allineati frontalmente e tre pari caratteristiche nella parte posteriore, uniti da coppie di tondini orizzontali e inclinati \varnothing 6 mm ogni 19 cm. I montanti sono dotati di piedini regolabili in acciaio zincato e verniciato con polveri epossidiche per esterni, colore grigio antracite o turchese pastello. I piedini presentano dei fori \varnothing 6 mm per l'eventuale fissaggio al suolo.

La luce tra i tondini verticali è di circa 5 mm e permette il passaggio di viti M4 atte a fissare crociere e schienali.

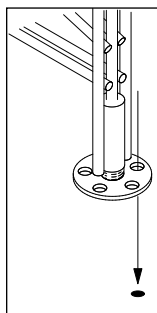

Dettaglio piedino
Fori per eventuale fissaggio a pavimento.

Codici: **4700E-AN, 4700E-TU**

Dimensioni: 43 x h. 152,5 cm

Descrizione: schienali in tondino d'acciaio elettrosaldato, zincato e verniciato con polveri epossidiche per esterni, colore grigio antracite o turchese pastello, composti da due coppie di tondini \varnothing 7 mm allineati posti ai lati, uniti da tondini orizzontali e inclinati \varnothing 6 mm ogni 19 cm. Gli schienali si fissano ai montanti tramite viti M4. Possono essere fissati tra di loro tramite connettore cod. 4750E-I.

Codici: **2940E-AN, 2940E-TU**

Dimensioni: L. 45 cm

Descrizione: crociere di sostegno posteriore composte da 2 tondini di acciaio \varnothing 8 mm stampato e forato all'estremità e al centro in acciaio zincato e verniciato con polveri epossidiche per esterni, colore grigio antracite o turchese pastello. I tondini sono fissati tra loro e ai montanti con viti M4 e dadi autobloccanti e rondelle.

Codici: **4750E-I**

Dimensioni: \varnothing 1,2 cm

Descrizione: connettore L. 17 x \varnothing 12 mm in acciaio inox per collegamento lineare di due schienali cod. 4700E-XX. Il connettore si fissa agli schienali tramite viti M4 e rondelle.

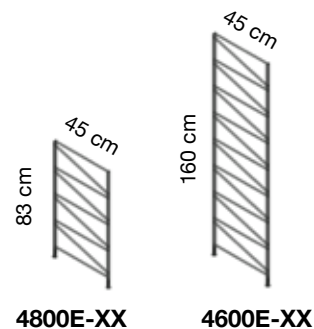

4800E-XX

4600E-XX

Colori disponibili



Grigio antracite



Turchese pastello
RAL 6034

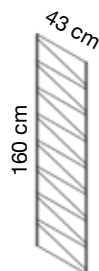

4700E-XX

Colori disponibili



Grigio antracite



Turchese pastello
RAL 6034



2940E-XX

Colori disponibili



Grigio antracite



Turchese pastello
RAL 6034

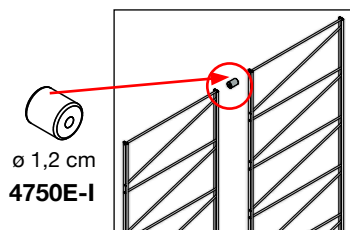

4750E-I

XX=variante colore

Codici: **4540E-AN, 4540E-TU, 4540E-VO, 4540E-VM**

Dimensioni: 43 X 43 cm

Descrizione: ripiani in lamiera d'acciaio zincata e verniciata con polveri epossidiche per esterni, colore grigio antracite, turchese pastello, verde oliva, o verde-bianco. L'assemblaggio dei ripiani è diretto sui tondini orizzontali dei montanti.



4540E-AN



Grigio antracite

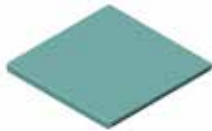

4540E-TU



**Turchese pastello
RAL 6034**



4540E-VO



**Verde oliva
RAL 6025**



4540E-VM



**Verde-bianco
RAL 6021**

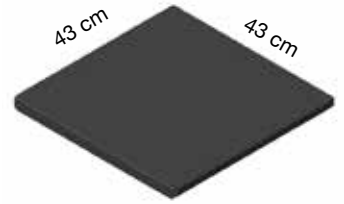

4540E-XX

Codici: **4560E-AN, 4560E-TU, 4560E-VO, 4560E-VM**

Dimensioni: 43 X 43 cm x h. 2 cm

Descrizione: vaschette stagne in lamiera d'acciaio zincata e verniciata con polveri epossidiche per esterni, colore grigio antracite, turchese pastello, verde oliva, o verde-bianco. L'assemblaggio delle vaschette è diretto sui tondini orizzontali dei montanti.

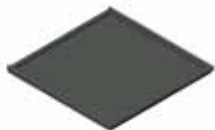

4560E-AN



Grigio antracite



4560E-TU



**Turchese pastello
RAL 6034**



4560E-VO



**Verde oliva
RAL 6025**



4560E-VM



**Verde-bianco
RAL 6021**

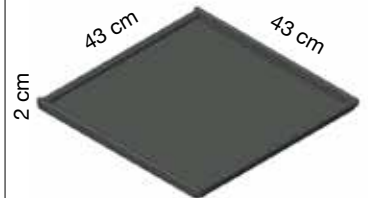

4560E-XX



Dettaglio vaschetta stagna

Codici: **4570E-AN, 4570E-TU, 4570E-VO, 4570E-VM**

Dimensioni: 43 X 43 cm x h. 6,5

Descrizione: vaschette in lamiera d'acciaio traforata zincata e verniciata con polveri epossidiche per esterni, colore grigio antracite, turchese pastello, verde oliva, o verde-bianco. L'assemblaggio delle vaschette è diretto sui tondini orizzontali o inclinati dei montanti.

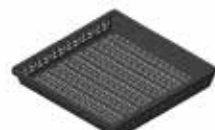

4570E-AN



Grigio antracite



4570E-TU



**Turchese pastello
RAL 6034**

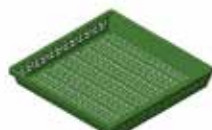

4570E-VO



**Verde oliva
RAL 6025**

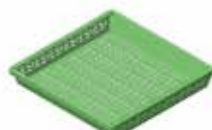

4570E-VM



**Verde-bianco
RAL 6021**

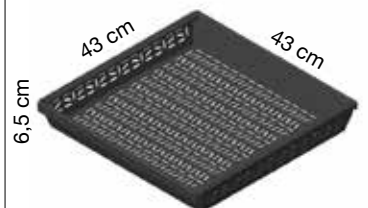

4570E-XX

XX=variante colore

Codici: **4530E-AN, 4530E-TU, 4530E-VO, 4530E-VM**

Dimensioni: L. 39,5 cm, P 17 cm, H. 25,5 cm, H. mensola 6,5 cm

Descrizione: mensole in lamiera d'acciaio traforata zincata e verniciata con polveri epossidiche per esterni, colore grigio antracite, turchese pastello, verde oliva, o verde-bianco. L'assemblaggio delle mensole è diretto sui tondini orizzontali degli schienali.

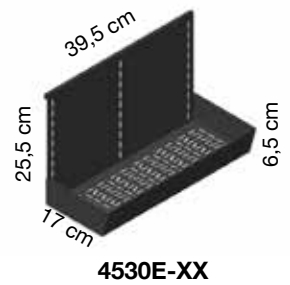

4530E-XX



4530E-AN



Grigio antracite

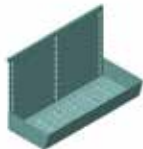

4530E-TU



**Turchese pastello
RAL 6034**

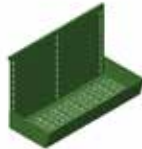

4530E-VO



**Verde oliva
RAL 6025**

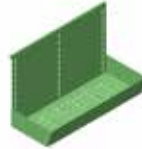

4530E-VM



**Verde-bianco
RAL 6021**

Codici: **4510E-AN, 4510E-TU**

Dimensioni: 43 X 43 cm x H 3 cm

Descrizione: sottopiano in lamiera d'acciaio zincata e verniciata con polveri epossidiche per esterni, colore grigio antracite o turchese pastello.

L'assemblaggio dei sottopiani è diretto sui tondini orizzontali dei montanti. Il sottopiano permette all'utente finale la possibilità di creare un proprio piano personalizzato da inserire nel sottopiano (ad esempio in legno o in marmo).

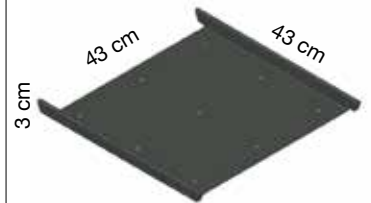

4510E-XX



4510E-AN



Grigio antracite



4510E-TU



**Turchese pastello
RAL 6034**

Codici: **4520E-ANS, 4520E-TUS, 4520E-ANC, 4520E-TUC**

Dimensioni: 43 X 43 cm x H 3 cm

Descrizione: ripiani in granito Serizzo spazzolato o in marmo di Carrara lucido fissati tramite viti a sottopiani in lamiera d'acciaio traforata zincata e verniciata con polveri epossidiche per esterni, colore grigio antracite o turchese pastello. L'assemblaggio dei ripiani è diretto sui tondini orizzontali dei montanti.

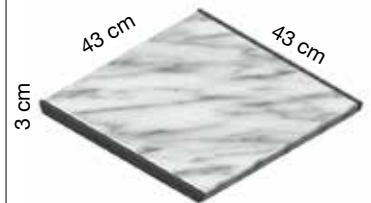

4520E-XX



4520E-ANS



Granito Serizzo

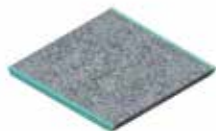

4520E-TUS



Granito Serizzo

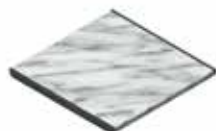

4520E-ANC



Granito Serizzo

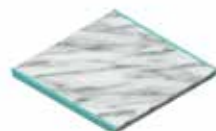

4520E-TUC



Granito Serizzo



Grigio antracite



**Turchese pastello
RAL 6034**



Grigio antracite



**Turchese pastello
RAL 6034**

XX=variante colore

Codici: **4580E-AN, 4580E-TU**

Dimensioni: 43 X 43 cm

Descrizione: ripiani in tondino d'acciaio e lamiera d'acciaio zincato e verniciato con polveri epossidiche per esterni, colore grigio antracite, turchese pastello.
L'assemblaggio dei ripiani è diretto sui tondini orizzontali dei montanti.



4580E-AN



Grigio antracite



4580E-TU



**Turchese pastello
RAL 6034**

Codici: **4590E-IS**

Dimensioni: 39 x 38,5 cm x H 42 cm

Descrizione: contenitore in acciaio inossidabile finitura scotch-brite AISI 304, dotato di ruote monodirezionali. Accessoriabile con separatore cod. 4591E-IS

Codici: **4591E-IS**

Dimensioni: 38 x H 36 cm

Descrizione: separatore in acciaio inossidabile finitura scotch-brite AISI 304 per cod. 4590E-IS

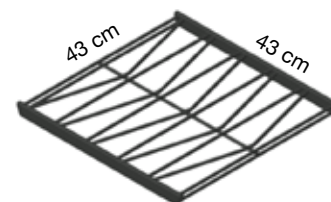

4580E-XX

XX=variante colore

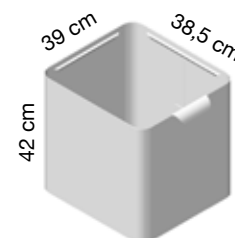

4590E-IS

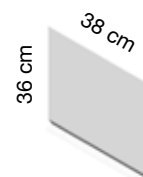

4591E-IS

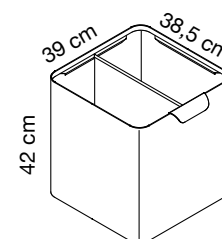

4590E-IS + 4591E-IS



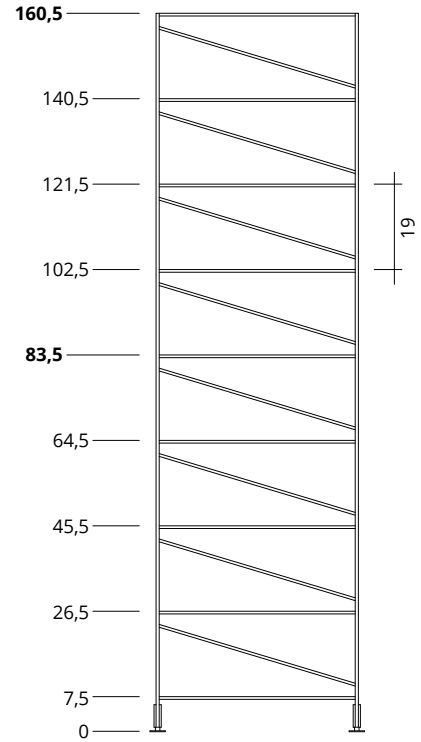
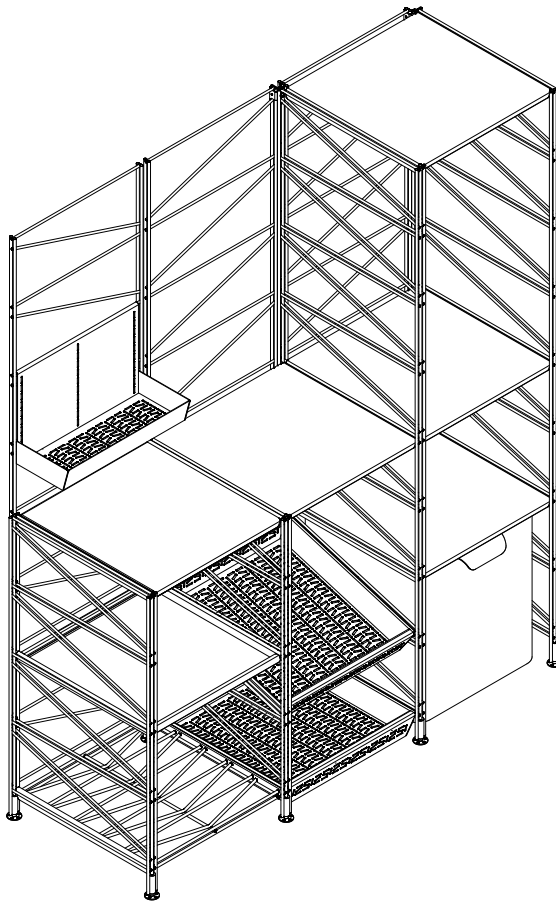

Acciaio zincato e verniciato con polveri epossidiche per esterni.
Galvanized and epoxy-powder coated steel for outdoor use.

RESISTENZA ALLA CORROSIONE
CORROSION TEST
NSS UNI EN ISO 9227:2017
Ore di esposizione / Hours of exposure
800

	2940E		4700E	
H 160	MIN 1	MAX 2	MIN 1	MAX 1
H 83	MIN 1	MAX 1	MIN 1	MAX 1

